

QUANTUM®

UNLOCK YOUR COLORS

QUANTUM® ARROW BOARD QT-1020



- Equipment Dimensions** ▲
pp. 03
- Specifications** ▲
pp.03
- Patterns & Modes** ▲
pp.04
- Quick Setup Guide** ▲
pp.05
- Fenix University** ▲
pp.06



Fenix Product Copyrights This price List and the mentioned Fenix products include or describe copyrighted Fenix material. Laws in the United States and other countries preserve for Fenix Industries and its licensors certain exclusive rights for copyrighted material, including the exclusive right to copy, reproduce in any form, distribute and make derivative works of the copyrighted material. Accordingly, any copyrighted material of Fenix and its licensors contained herein or in the Fenix products described in this Price List may not be copied, reproduced, distributed, merged or modified, transmitted, transcribed, stored in retrieval system or translated into any language or computer language, in any form or by any means, without prior written permission of Fenix Industries, Inc. Fenix and the stylized Fenix logo are registered in the U.S. Patent & Trademark Office.



SAFETY REGULATIONS & WARRANTY

Safety Regulations

The following provides all the information necessary to safely operate the previously listed products of Feniex Industries, Inc. Please read this manual thoroughly before installing or operating your new product in order to prevent any damage or injury. Failure to follow the listed instructions in this manual may result in damage to your products or personal injury.

- Proper installation of this product requires good knowledge of automotive systems, electronics and procedures.
- Please guarantee all vital components of the vehicle are not in danger of being damaged by drilling holes necessary for installation. Check all sides of the mounting surface before drilling any holes into the vehicle.
- Do not install this product in any way that interferes with the deployment of the air bag. Doing so may damage the effectiveness of the air bag and can lead to serious personal and vehicle injury. The installer will assume full responsibility of proper installation of the new unit.
- Please clean the mounting surface before installation of the unit when using tape, brackets, magnet, Velcro or suction cups.
- The product's ground wire must be connected directly to the Negative (-) battery post for effective use of the unit. Please follow all wiring guidelines provided to guarantee long lifespan and productivity. Failing to follow these instructions may result in damage to the product.

Warranty

Feniex Industries, Inc. warranties to the original purchaser that all our products shall be free from defects in material and workmanship. Feniex Industries' speakers, sirens, rocker panels, AM600 Beacons, Torch Lights, AI lightbars, AI Cubes, AM900 Work Lights, 8.5" Dome Lights, flashlights, Remote Spot Lights and controllers are warranted for 2 years from the manufacturing date. In addition, all other products are warranted for 5 years from the manufacturing date.

If a warranty problem occurs, please contact customer support at 1.800.615.8350 or visit the web site at www.Feniex.com.

If the product needs to be returned for repair or replacement, call our customer support line to receive a return merchandise authorization number.

Operational times are from 10 a.m. to 5 p.m. central time, Monday through Friday. Please do not send in product without contacting support first for a RMA number.

Service After Expiration

Feniex Industries will still provide service for all products after expiration of the warranty. For any issues, call the customer support line. In some instances it may be necessary for the product to be shipped, freight prepaid and insured for loss or damage to Feniex headquarters.

Warning! Utilizing non-factory screws and mounting brackets may result in loss of warranty coverage.

Copyright

This instruction manual and the Feniex products described in this instruction manual may include or describe copyrighted Feniex material. Laws in the United States and other countries preserve for Feniex Industries and its licensors certain exclusive rights for copyrighted material, including the exclusive right to copy, reproduce in any form, distribute and make derivative works of the copyrighted material. Accordingly, any copyrighted material of Feniex and its licensors contained herein or in the Feniex products described in this instruction manual may not be copied, reproduced, distributed, merged or modified in any manner without the express written permission of Feniex Industries, Inc.

Feniex Product Copyrights

The products described in this document are the property of Feniex Industries, Inc. It is furnished by express license agreement only and may be used only in accordance with the terms of such an agreement. Products and documentation are copyrighted materials. Making unauthorized copies is prohibited by law. No part of the product or documentation may be reproduced, transmitted, transcribed, stored in retrieval system or translated into any language or computer language, in any form or by any means, without prior permission from Feniex Industries, Inc.



▲ WIRING DIAGRAM



Quantum®
wiring harness

Wire: Function:

Red	12V+
Black	Ground
Green	Data Wire A
White	Data Wire B
Blue	Input 1
Orange	Input 2
Brown	Input 3
Gray	Input 4
Yellow	Input 5
Violet	Input 6
Blue/White	Input 7
Orange/White	Input 8
Brown/White	Input 9
Green/White	Input 10

▲ SPECIFICATIONS

Warranty	5 years
Voltage	10-18 Volts DC
Current Draw	12 Amps

▲ EQUIPMENT DIMENSIONS

42.46" L x 1.3" W x 15" H

▲ WIRING HARNESS

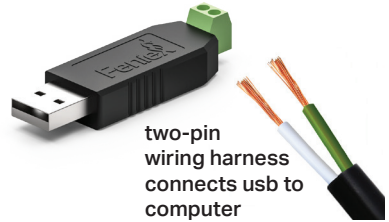

two-pin
wiring harness
connects usb to
computer

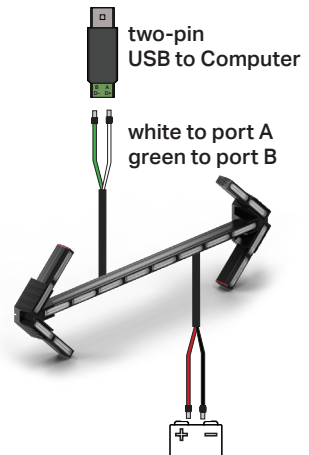

two-pin
USB to Computer

white to port A
green to port B

▲ PATTERNS

1	Attack
2	Cluster
3	Cluster Mix
4	Combo Single
5	Combo Triple
6	Half-Half Single
7	Half-Half Triple
8	One-One Single
9	One-One Triple
10	Two-Two Single
11	Two-Two Triple

12	All-On Single
13	All-On Triple
14	Raging Beacon
15	Figure 8 Chase
16	Night Ride Crossover
17	Hale Storm
18	Pulse
19	I/O Flux
20	Spectrum
21	Progressive Pursuit

▲ MODES

1	Tail Signal
2	Cruise Signal
3	Flashing
4	Arrow Direction
5	Turn Signal

6	Brake Signal
7	Flood & Alleys
8	Low Power
9	Cut Off

▲ INPUTS

10 Inputs / 28 Inputs when paired with Quad Converter

▲ BRIGHTNESS

10%	100%
50%	Park Pattern

▲ QUICK SETUP GUIDE

■ 1. Unbox Quantum® Product

Remove the Quantum® product from its packaging. Locate the Quantum® product and the 2-pin USB drive:

two-pin
USB Connector



■ 2. Download Quantum® Unlock Software

Visit website http://unlock.feniex.com/site/change_log or use the QR code to download the Quantum® unlock software.



■ 3. Install Quantum® Unlock Software

The Quantum® Unlock Software is available for both PC and Mac. The software will allow the user to completely configure their Quantum Products (i.e color, modes, functions).



■ 4. Connect Quantum® to your Computer

Open Quantum® Software. Connect the Quantum® product to your computer using the 2-pin USB connector.

two-pin
USB to
Computer



■ 5. Power the Quantum® Product

Connect the red wire to a 12v+ terminal and the black wire to a 12v- ground to power on your Quantum® product.

- ▶ white to port A (D+)
- ▶ green to port B (D-)

■ 6. Open Feniex University

Open Feniex University to follow step-by-step instructions on how to configure your Quantum product.





FENIEX UNIVERSITY

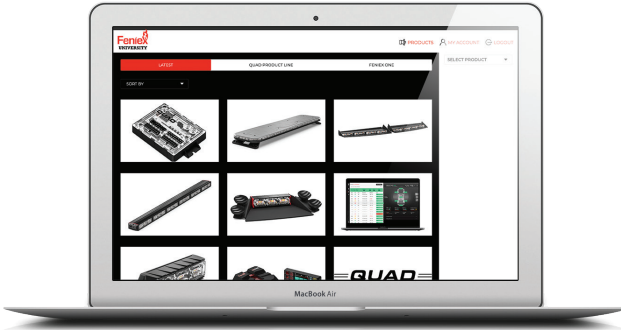

■ Feniex University

Before installing the Quantum product, watch our instructional video series; Feniex University. Get an in-depth look at how to program and install your products using the Quantum Unlock Software



■ Visit Feniex University:

feniexuniversity.com

■ Download Quantum Unlock Software:

http://unlock.feniex.com/site/change_log





▲ QUANTUM SOFTWARE

■ Unlocking Quantum

Every Quantum product is programmed to be a “Single” color platform from the factory. Single color implies one color LED per module as a “Single” color use. All 4 colors can be used on this platform as a single color or single function operation (i.e., if my single color lightbar has takedowns it is defaulted with a white colored module. I cannot change my takedowns as red, blue, or amber in color). Each function like STT, Alley, and Takedowns are defaulted to a specific-colored module. Dealers could unlock different levels through their dealer portal.

■ Dealer Unlock with Hardware & User Interface

Eligible dealers will have access to a Quantum dealer user interface. This will allow the dealer to make any level changes to their customer’s product(s) and configure their product to their specific needs. A USB dongle will be provided for every Quantum product.

■ Dealer Unlock with Hardware & User Interface

Every end user can make any configuration based on their level of purchase through their dealer’s network. On single, dual, and trio level of purchase they have up to 30 days to make any necessary changes to their product(s) before it locks in permanently. No changes are available after 30 days. Any upgrades are required by your authorized Feniex dealer.

■ Configuring Products

Levels:

- ▶ Single
- ▶ Dual
- ▶ Trio
- ▶ Quad

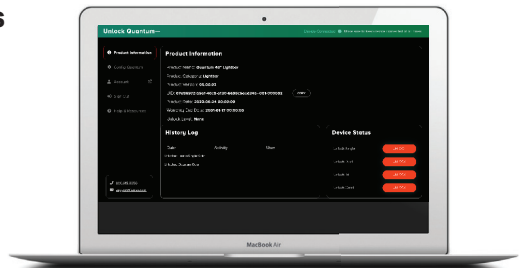



▲ SINGLE COLOR OPTIONS

The product can be in any color scheme utilizing all 4 colors on a single module and the use of all 5 options (i.e., Takedown, alleys, and stop, turn, and tail). This configuration is the most widely used as a single-color platform to most agencies nationally and internationally. It covers the basic of police and fire color scheme widely known to our industry. In this illustration this lightbar is fully populated with every possible Quantum function available and has more capabilities for a budget department than they need.

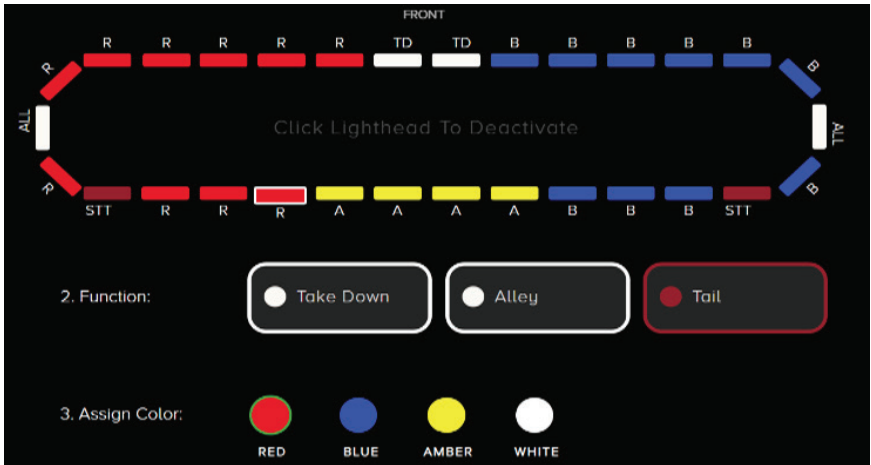

Most common single-color configuration for Police, Fire & EMS:
Driver red, passenger blue, takedowns, alleys, and STT [Stop, Turn, Tail]

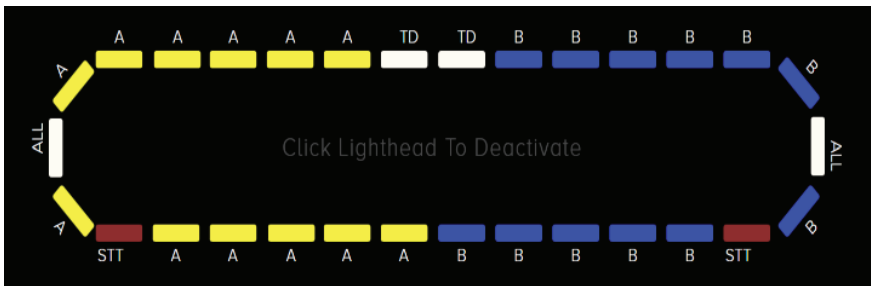

Most common single-color configuration for Public Safety with all available options:



DUAL COLOR OPTIONS

The most popular economical lightbar configuration. This setup encompasses the standard driver red, passenger blue, adding white to their emergency flash pattern, with flood takedowns and flood alleys (modular capability), full traditional amber directional, rear worklights and Stop, Turn, and Tail.



Most common dual-color configurations for Police, Fire & EMS:

Driver red, passenger blue, flood takedowns, flood alleys, amber arrows, STT, Work lights.

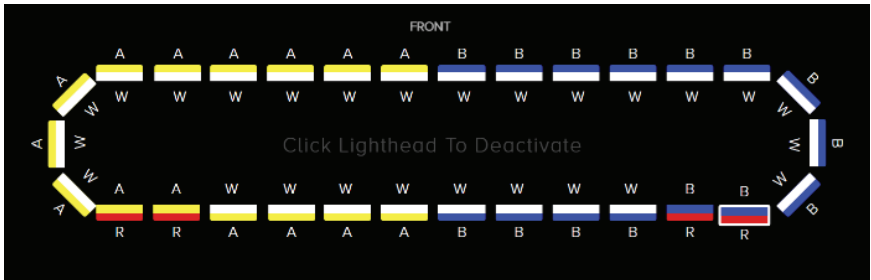

A popular public safety build that is attractive w/ every function wanted. While maintaining the traditional amber and blue a flood 360 is a must for night work while adding the DOT approved lighting functions needed with stop, turn and tail.

▲ TRI COLOR OPTIONS

This color combo sets the bar for an enhanced traditional red and blue bar. An infinite of red and blues throughout the entire lightbar with an overkill but necessary all white lights 360 degrees. With our flash patterns and an infinite of red, blues, and white the lightbar will absolutely stand out. Stop, turn, and tail is always optional. To the predecessor standard build of driver red, and passenger blue and 2 takedowns this setup will cover more area in color than needed.

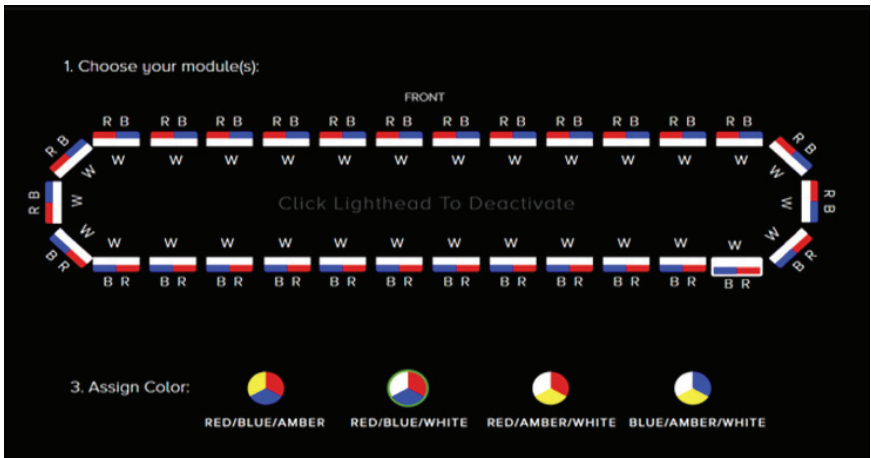

▲ QUAD COLOR OPTIONS

Enjoy all four colors any time!





▲ **QUAD CONVERTER** [NOT INCLUDED]

Quantum programming unlocks more modes and functionality for your Quantum product. Quantum products (excluding full-size and mini lightbars), come with 10 wires for input programming. The Quad Converter increases your modes to 28 inputs. Follow the steps below to connect your product to the Quad Converter:

■ **Connecting Quantum® to Quad Converter**

Connect your Quantum product to the Quad Converter by using your data wires to the A and B inputs (Green wire to A, White wire to B). Power your Quantum product by connecting the red wire to a 12V+ terminal and the black wire to a 12V- terminal or ground. Power your Quad Converter to a 12V battery by connecting the red wire to a 12V+ terminal and the black wire to a 12V- terminal or ground.

Use the provided Quad converter wiring harnesses to connect the wires to inputs 1-28.

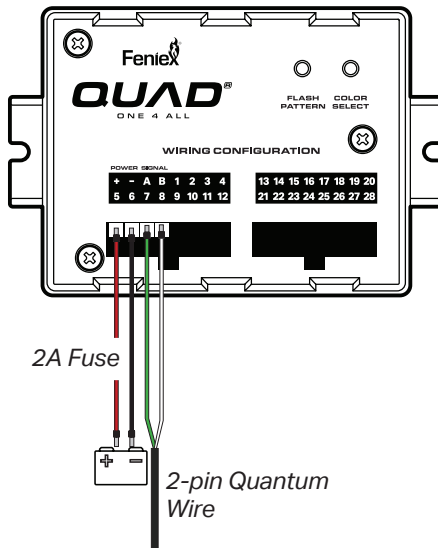

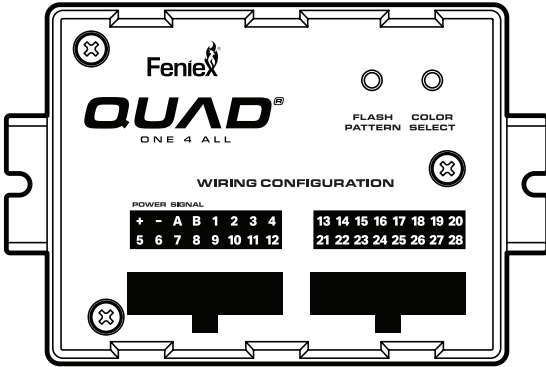

▲ QUAD CONVERTER

1	Input 1	15	Input 15
2	Input 2	16	Input 16
3	Input 3	17	Input 17
4	Input 4	18	Input 18
5	Input 5	19	Input 19
6	Input 6	20	Input 20
7	Input 7	21	Input 21
8	Input 8	22	Input 22
9	Input 9	23	Input 23
10	Input 10	24	Input 24
11	Input 11	25	Input 25
12	Input 12	26	Input 26
13	Input 13	27	Input 27
14	Input 14	28	Input 28



PROGRAMMING QUAD CONVERTER [CONT.]

■ Improved Quantum Functions:

Quad converter for all Quantum products is now programmable. There are up to 28 programmable inputs of your choice. They can have an infinite of flash patterns, 28 different alley light configurations, 28 variable arrow functions, etc.

► *All programming will be done through the end-user app when configuring.*

■ Understand the Quad Converter

Each input shows in the illustration below is a direct correlation with the inputs on the Quad Converter.

The end-user is required to map out their specific configurations to a 12V+, triggering a controller like the 4200 Data Link, Mini 4200, Typhoon, Feniex One (analog 12V+ triggers).

Example of User Interface:

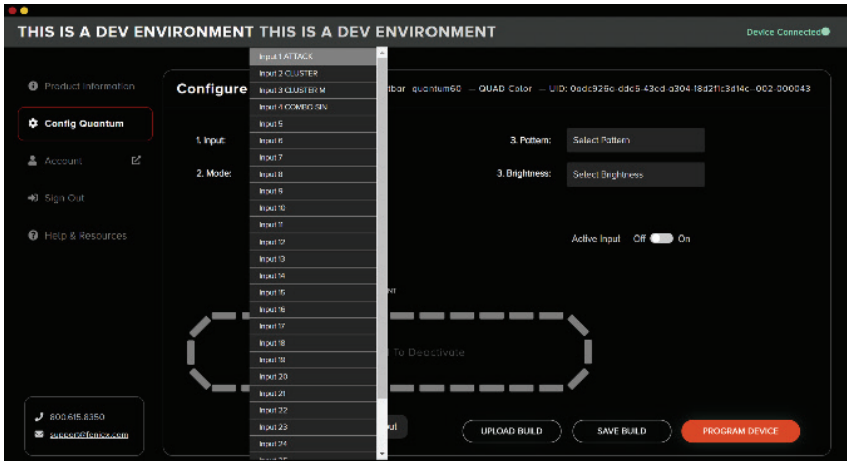

PAYMENT

Purchasing and upgrading your Quantum products is easy. Start by connecting your Quantum product to your computer and opening your Quantum Unlock Software and clicking "Account".

Account ■

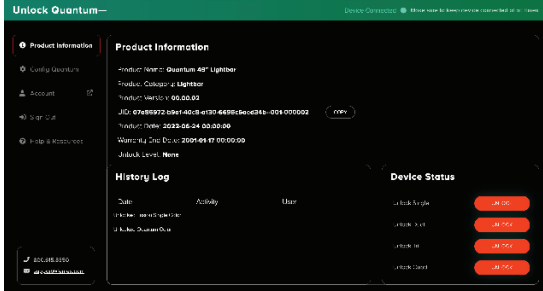

You will be redirected to another screen for payment information. Add a Payment Method by selecting "Add a New Card".

■ **Pay to Unlock:** Unlock Once added, select "Pay to Unlock" to upgrade your Quantum products.

■ **Payment History:** To view past purchases with Quantum, select "Purchase History" in the right side menu:

Pay to Unlock
Purchase History
Account ■

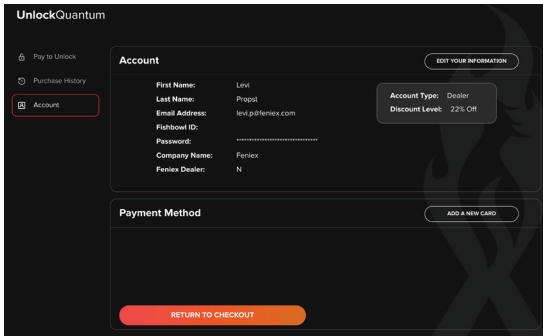



PAYMENT (DEALER ACCESSIBILITY)

The dealer can setup their own account on a provided web link that is accessible through their inside sales representative.

